

# ViviCam T024 Digital Camera

## User Manual



**Vivitar®**

© 2010 Sakar International, Inc. All rights reserved.

Windows and the Windows logo are registered trademarks of Microsoft Corporation.

All other trademarks are the property of their respective companies.

## Table of Contents

Introduction .....	2
Key Features.....	2
What's Included.....	2
Computer System Requirements for Windows OS .....	3
Computer System Requirements for Macintosh OS.....	3
A Quick Look at Your Camera.....	4
Preparing Your Camera for Use.....	5
Installing SD Memory Card.....	6
Starting Your Digital Camera.....	8
Camera Mode.....	9
Video Mode .....	30
Playback Mode .....	33
Install the Vivitar Experience Image Manager Software .....	44
Connect your camera to the computer.....	46
Get photos and videos from your camera to your computer.....	47
Get started! .....	48
Transfer media from my camera to my computer manually (Using Windows) .....	49
Transfer media from my camera to my computer manually (Using Macintosh) .....	49
Maintenance of Your Digital Camera .....	50
Sakar Warranty Card.....	50
Technical Support.....	51
Technical Specifications .....	52
Troubleshooting.....	53

## Introduction

Thank you for purchasing the ViviCam T024 12.1 Mega-Pixel Digital Camera with Auto-Focus zoom lens. Everything you need to take quality digital photos and videos is included with your camera.

Vivitar makes capturing those special moments so easy.

Please read this manual carefully first in order to get the most out of your digital camera.

## Key Features

- 4X Digital Zoom
- 12.1 mega pixels camera
- 2.4 inch TFT LCD
- Auto Flash
- Red Eye Reduction
- Self Timer
- Anti-Shake
- Pictbridge Ready
- Smile & Face Detection
- Vivitar Experience Image Manager software for uploading and managing photos and videos to or from the most popular photo sharing and social network websites.

## What's Included

- Digital Camera
- Vivitar Experience Image Manager software Installation CD
- USB cable
- Quick Start Guide
- Wrist Strap

## **Computer System Requirements for Windows OS**

To be able to download photos and videos to your PC you will need the following minimum configuration:

- Pentium 4 processor or above with Windows XP service pack 2, Windows Vista or Windows 7
- 512 MB RAM, with 100MB of free disk space
- 1024 x 768 Recommended screen resolution
- 16-bit color or higher display adaptor
- CD-ROM Drive
- QuickTime 6 or higher
- Microsoft Internet Explorer 7 or higher
- Windows Media Player 10 or higher
- Internet connection required

## **Computer System Requirements for Macintosh OS**

- Macintosh with Intel processor running Mac OS X v10.5 or later
- 256 MB RAM, 100 MB free disk space
- Display: 1024 x 768 or higher-resolution monitor
- QuickTime 6 or higher
- Internet connection required

## A Quick Look at Your Camera

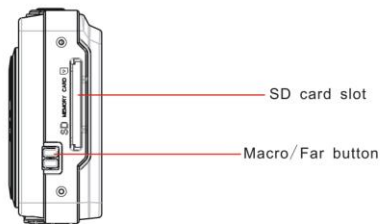
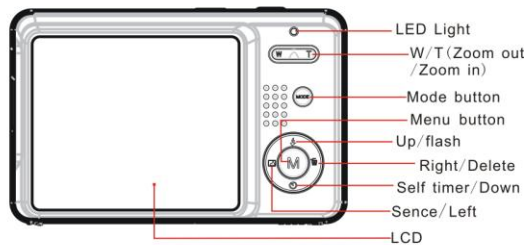
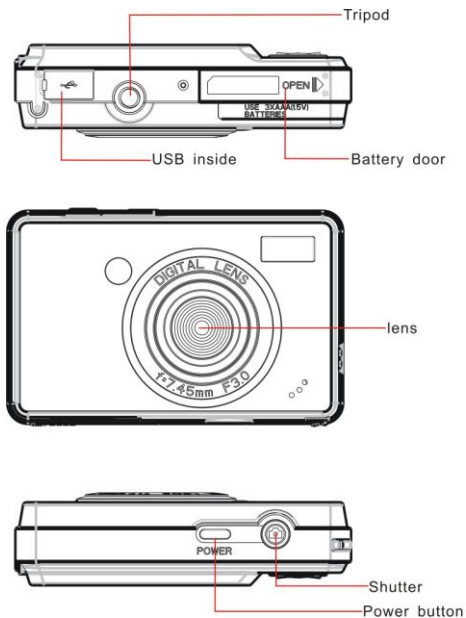

## Preparing Your Camera for Use

Your digital camera needs 3 AAA batteries in order to operate. Alkaline batteries are recommended.

1. Slide and open the battery door on the bottom of the camera.

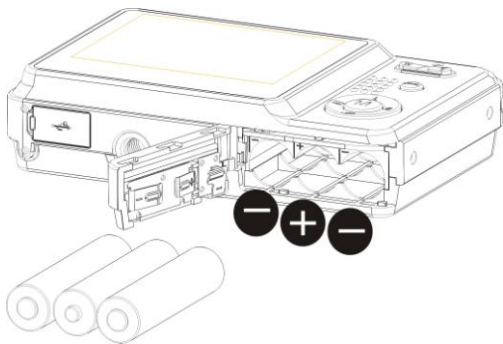

2. Insert the batteries correctly with the correct polarity facing up.
3. Close the battery door.
4. On powering on your camera the battery icon will appear on the bottom left of the LCD screen.



Full battery power



Medium battery power



Low battery power

**Note:**

1. A “Low battery” message will flash on the LCD when the battery power is insufficient. Shortly thereafter your camera will power off.
2. Please remove your batteries when you don't intend to use your camera for a long time.
3. Test photos taken with the camera should be downloaded otherwise they will be lost when the camera loses power and turns off or when the battery door is opened to replace the batteries.

## Installing SD Memory Card

An external memory card is required for normal use. Your camera supports any compatible SD memory card (up to 8GB).

Adding a memory card will allow you to increase the capacity of your camera before you have to transfer test photos to your PC.

1. Locate the Memory Card slot on the side of the camera.
2. Insert the Memory card into the slot in the correct direction. (see the sketch below).

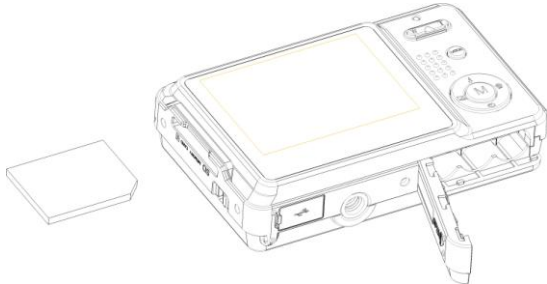

3. Push the card in until you feel it “click” into position. The top of the card should be flushed with the surface of the camera. An **SD** icon will appear on the LCD screen after you turn on your camera.
4. Once the external memory card is inserted into the camera all the images taken with the camera will be stored on the card.
5. Please make sure the card is not locked. No images can be transferred to the card if it is locked.

**Note:**

1. Limited internal memory is provided for one test photo. The photo will be deleted when the camera's power is turned off or if the batteries are removed. Please download the photo before powering off.
2. If there is a photo in the internal memory when you insert the card into your camera, a “Copy to card” message will appear on the LCD with Yes or No options. On selecting ‘Yes’ the photo will now be copied to your card.
3. Formatting will delete all data on the SD memory card including protected data.
4. Don't remove the SD card during formatting as this may damage the card and render it unusable.
5. When your card is full, download the media on the SD card to your PC and delete the photos and videos from it in order to continue using your camera to capture more high quality photos and videos.



## Starting Your Digital Camera

### Power on



Press the Power button on the top of the camera to turn on your camera. The LCD will light up indicating that your camera is on and ready for use.

### Power off

Press the Power button to turn off your camera. When there is insufficient battery power a red icon  will appear on the LCD screen. Your camera will automatically power off after a few seconds.



### Mode selection

Your digital camera has 3 main modes - Camera mode, Video mode and Playback mode.

-  The Camera mode is for you to take still photos, adjust the camera settings and change the way the camera is setup.
-  You can shoot video files while in Video mode.
-  In Playback mode you can preview photos and videos as well as being able to delete, rotate, protect, crop and print your photos.

In order to select the mode, please follow the below steps:

1. By default the Camera mode appears first on powering on the camera.

2. Press the MODE button to toggle between the 3 modes.
3. The Camera mode will have an  icon in the top left corner of the LCD screen. The Video mode will have an  icon and the Playback mode a  icon will appear in the top left corner of the screen.

## Camera Mode

This is the default mode when turning on your camera.

## Taking Photos

1. Compose your shot using the LCD screen.
2. Hold the camera steady and press the Shutter button to take the photo.
3. There will be a short delay while the camera saves the JPEG photo to memory.

After each photo is taken (when the camera returns to icon mode) the numbers of photos left to shoot at the selected resolution is displayed on the top right of the LCD screen.

- When the camera's memory (photo capacity) is full, the LCD screen will display a message - "Memory Full, Insert a SD memory card to Transfer and Take More Photos!"
- Either download the photo to your computer using the Vivitar Experience Image Manager software as described below in the section "**Transfer photos and videos to your computer**" and

thereafter delete them from your SD card or insert another SD card to continue taking more photos and videos.

**Note:** This camera needs a SD memory card to operate normally. The limited internal memory allows you to take one test photo that will be erased when the camera powers off.

## Digital Zoom

You can magnify your subject up to 4 times using the digital zoom. Press the **T** button to zoom in on the object and press the **W** button to zoom back out.





The following icon will appear on your LCD screen.



## Macro/Far shooting

The camera has a function that allows you to capture objects up close or very far distances per your request.

Macro shooting (up to 80cm):

1. Slide the Macro/Far switch on the side of the camera near the SD card slot to the  position.
2. The icon  will appear on the LCD screen to indicate that the macro shooting is on.

Far shooting:

1. Slide the Macro/Far switch on the side of the camera to the  position .
2. The icon  will appear on the LCD screen to indicate that the far shooting function is on.



## Flash

In low light conditions it is best to use the built-in flash. You can also use the flash to compensate for backlight conditions.





To set the flash:

**Note:** Please move the Macro/Far setting to Far mode. The flash can only be use when the camera is in Far mode. If you are in the Macro close up mode and try to use the flash, a message will appear on the LCD to remind you that you are in "Macro Mode". Select the Macro setting option to change to the Far mode in order to use the flash.

1. Press the Flash/Up button.
2. The  icon appears on the LCD screen. This will activate the automatic flash.
3. The  icon as well as the red LED will begin to flash indicating that the flash is charging.
4. Press the Flash button again for the  icon to appear on the LCD screen. This means the flash function has been "forced on" (manual flash).

If the flash is not ready, a red LED will light up and the  icon will flash repeatedly- wait until the flash is ready before taking a photo.

**Note:** A “**low battery**” warning will appear on the LCD screen if there is insufficient battery power to operate the flash.

5. Press the Flash button until the  icon appears on the LCD indicating that the Red-Eye reduction is on.
6. Press the Flash button until the  icon appears again. This will turn off the flash function. This is the default flash setting.

### Short cut buttons on the MENU dial

The camera has 3 short cut buttons on the MENU dial to make for quick access to the following settings: *Scene (Left button), Self-timer (Down button) and Delete (Right button)*

Pressing the relevant button will activate the setting options.

- **Scene** – the 9 scene options appear on the LCD for you to select:  
*Auto, Night Portrait, Night Scenery, Portrait, Scenery, Sport, Party, Beach, High Sensitivity*
- **Self-timer** – Press the Self-Timer button to toggle through the 4 Self-Timer options:  
*2 sec, 5 sec, 10 sec or Off*
- **Delete** – Pressing this button will delete the last image (Photos or Videos) captured.
  1. Press the Delete (Right)  button.
  2. A “This Image” delete confirmation message appears on the LCD with “Yes” or “No” options.

3. Press the Left/Right button to choose “Yes” to delete the photo or “No” to cancel the delete.
4. Press the MENU button to confirm.  
If you selected Yes, the last image is deleted.

Each setting will be explained in its own section below.

## Scene

Your camera comes supplied with many scenes for you to take photos in almost any environment. Scenes included with your camera are - *Auto, Night Portrait, Night Scenery, Portrait, Scenery, Sport, Party, Beach or High Sensitivity.*

Choose the scene in accordance with the light and environmental conditions prevailing at the time of taken the photo.

1. Press the MENU button.
2. Press the Right/Left button to select the Scene  icon.
3. The Scene menu appears in the center of the LCD.
4. Press the Up/Down buttons to select the scene you want to use.

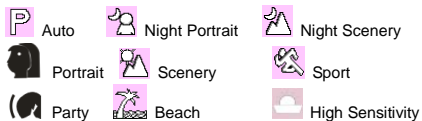

5. Press the MENU button to confirm, save your choice and exit to the camera standby mode.
6. The selected icon appears next to the camera icon on the top left of the LCD screen.

## Image Size

The image size settings determine the quality and number of photos that can be saved and the amount of memory required for each photo. The higher the photo quality the more memory it will take. The image size and quality will also affect the maximum size you can effectively print your photo. To set the Image size:

1. Press the MENU button.
2. Press the Right/Left button to select the **MP** icon.
3. The Image Size menu appears in the center of the LCD.
4. Press the Up/Down buttons to select the image size you want to use.

*(12M) 4000 x 3000, (10M) 3648x2736, (8M) 3264x2448, (7M HD) 3648x2048, (5M) 2592x1944, (3M) 2048x1536, (2M HD) 1920x1080 and (VGA) 640x480*

5. Press the MENU button to confirm, save and exit to the camera standby mode.
6. The selected image size icon will appear on the top of the LCD screen.

**Note:**

1. For Image sizes higher than 3M a SD card need to be inserted into the camera.
2. Your camera has two HD “7M” and “2M” high definition image sizes.

### **Anti-Shake**

Your Digital Camera has a function that prevents photos coming out blurry as a result of trembling or shaking when taking the photo. You are not required to use a tripod in order to take good quality photos.

1. Press the MENU button.
2. Press the Right/Left button to select the  icon
3. The Anti-Shake menu appears in the center of the LCD.
4. Press the Up/Down button to select Anti-Shake On or Off.



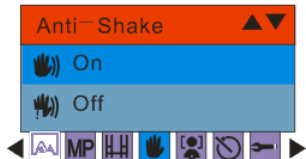

5. Press the MENU button to confirm, save and exit to the camera standby mode.
6. The anti-shake icon selected will appear on the bottom of the LCD screen.

## Face Detect

Your camera supports face detecting that allows you to take better portrait photos.

1. Press the MENU button.
2. Press the Right/Left button to select the  icon.
3. The Face Detect menu appears in the center of the LCD.
4. Press the Up/Down button to select Face Detect On or Off.

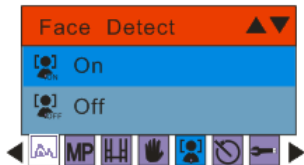

5. Press the MENU button to confirm, save your choice and exit to the camera standby mode.
6. The Face Detect icon selected will appear on the bottom of the LCD screen.

## Self-Timer

You can include yourself in a photo by using this feature to delay the time between you pressing the Shutter button and when the photo is actually taken. It is recommended that you use a tripod or place the camera on a flat and sturdy surface when using the self-timer.

1. Press the MENU button.
2. Press the Right/Left button to select the  icon.
3. The Self -Timer menu appears in the center of the LCD.
4. Press the Up/Down button to select one of the self timer options:



5. Press the MENU button to confirm, save your choice and exit to the camera standby mode.
6. The Self-Timer icon selected will appear on the top of the LCD screen.
7. Press the Shutter button until you see the self-timer count-down begin in the center of the green frame that appears on the LCD. Your camera will count down 2, 5 or 10 seconds as per your choice, the LED will flash and then automatically take the photo.

## Setup

You can adjust the way your camera is setup with 10 setup options:

*Exposure, ISO, White Balance, Sharpness, Quality, Date, Auto Power off, Language, Format and Default Setting.*

1. Press the MENU button.

2. Press the Right/Left button to select the  icon.
3. The Setup menu appears in the center of the LCD.
4. Press the Up/Down button to select one of the setup options:

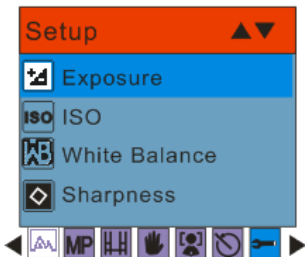

## ***Exposure***

This setting allows you to control the brightness of your images.

1. Press the MENU button.
2. Press the Up/Down buttons to select an Exposure value (from 3 brightest to -3 darkest) from the Menu that appears:



3. Press the MENU button to confirm, save and exit to the camera standby mode.
4. The Exposure icon for the option you selected appears on the bottom of the LCD.

### ***ISO***

This is a special function that allows you to compensate the light conditions when the light source is not good and you also specifically do not wish to use a flash or tripod. When using ISO sensitization, please choose the low value ISO to prevent spots or blotches appearing on your photo.

1. Press the Up/Down buttons to select the ISO option in the Setup menu.
2. Press the MENU button.
3. Press the Up/Down buttons to select an ISO value from the Menu that appears:

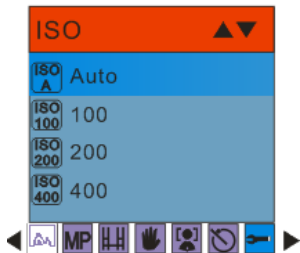

4. Press the MENU button to confirm, save and exit to the camera standby mode.
5. The ISO icon for the option you selected appears on the bottom of the LCD.

### **White Balance**

This setting allows the camera to adjust the color of your photos according to the color of your light source.

1. Press the Up/Down buttons to select the White Balance option in the Setup menu
2. Press the MENU button.
3. Press the Up/Down buttons to select a White Balance option from the Menu that appears:

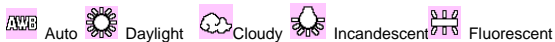

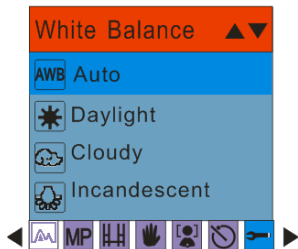

4. Press the MENU button to confirm, save and exit to the camera standby mode.
5. The LCD screen will be adjusted as per the White Balance option you selected.

### ***Sharpness***

This setting allows you to adjust the sharpness of your images, making edges more or less distinct.

1. Press the Up/Down buttons to select the Sharpness option in the Setup menu
2. Press the MENU button.
3. Press the Up/Down buttons to select a Sharpness option from the Menu that appears:

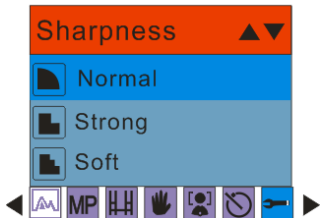

4. Press the MENU button to confirm, save and exit to the camera standby mode.
5. The LCD screen will be adjusted as per the Sharpness option you selected.

### **Quality**

The quality of your photos also affects the number of shots you can take. A HIGH setting means you can take fewer photos, but they will be of better quality. The default value is Fine.

1. Press the Up/Down buttons to select the Quality option in the Setup menu.
2. Press the MENU button.
3. Press the Up/Down buttons to select a Quality option from the Menu that appears:



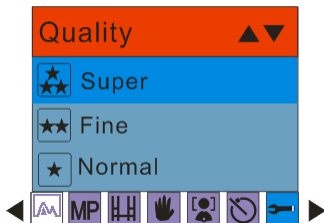

4. Press the MENU button to confirm, save and exit to the camera standby mode.
5. The Quality icon for the option you selected appears on the bottom left corner of the LCD.



*Super quality*



*Fine quality*



*Normal quality*

## **Date**

This allows you to set the system time which will be displayed on the photos.

1. Press the Up/Down buttons to select the Date option in the Setup menu.
2. Press the MENU button.
3. Press the Up/Down buttons to select a Date option from the Menu that appears:

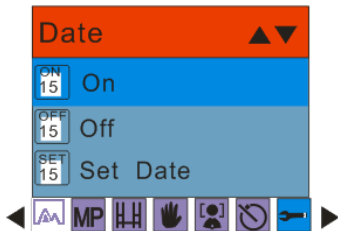

- On selecting “On” the date will appear on the photo once it is taken.
- On selecting “Off” no date will appear on the photo.
- On selecting “Set Date” the Set Date settings screen will appear. You will be able to change the date settings that will appear on the photo once it is taken.

**To Set the date:**

1. Press the Up/Down button to enter Set date option.
2. Press the MENU button.
3. Press the Right/Left button to select and highlight the Year, Month, Day, Hour, Minute, Second and Date Format type. Press the Up/Down button to set the Date, time and format.

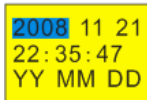

4. Press the MENU button to confirm, save the changes and exit.

### ***Auto Power Off***

By default, if your camera is idle for 60 seconds it will automatically be powered off. Use the Auto Power Off option to change this setting:

1. Press the Up/Down button to select the Auto Power Off option in Setup menu.
2. Press the MENU button.
3. Press the Up/Down buttons to select an Auto Power Off option from the Menu that appears:

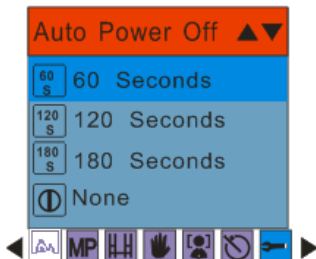

4. Press the Up/Down button to select a time that the camera will automatically power off if inactive.

Note: If you select None, the camera will not be powered off until the battery power is depleted or the camera is turned off manually.

5. Press the MENU button to confirm, save and exit to the camera standby mode.

### ***Language***

Your digital camera supports only English for this version.

### ***Format***

This function will format the memory card and will erase all files in memory including files that

have been protected.

**Important:** Please use this function with caution. Once formatted all the images stored in the memory will be erase. This process is irreversible. Please download all images to the PC before formatting the card.

1. Press the Up/Down button to select the Format option from the Setup menu.
2. Press the MENU button.
3. Press the Up/Down button to select OK.

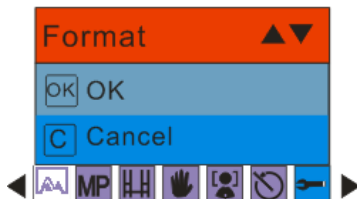

4. Press the MENU button to confirm.
5. A Format confirmation message appears.



6. Press the Right/Left button to select “Yes” to format, “No” to exit.
7. Press the MENU button to confirm and begin the format.

8. Once the SD card is formatted all the images sitting on the card will be erased and the camera will revert to the camera standby mode.

### ***Default Setting***

You can restore your camera to the original factory settings.

1. Press the Up/Down button to select Default Setting in the Setup menu.
2. Press the MENU button.
3. Press the Up/Down button to select OK

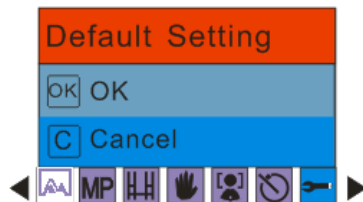

4. Press the Up/Down button to select OK to set to default setting or Cancel to exit.
5. Press the MENU button to confirm.
6. If you selected OK, a Default Setting confirmation message will appear:

### Default Setting

Yes

No

7. Press the Right/Left button to select Yes to reset to the default setting or No to exit the menu.
8. Press the MENU button to confirm and reset the camera to the original factory settings.

## Video Mode

Press the MODE button to select the Video mode.

**Note:** An SD card (up to 8GB) needs to be inserted in order to use the video mode normally.

When the  icon appears on the top left corner of the LCD screen this indicates that you are in Video mode.

1. Prepare the object or subject you wish to record.
2. Press the Shutter button to begin shooting the video.
3. The elapse time will appear on the top right of the LCD screen and the icon  will flash on the

LCD screen.

4. Press the Shutter button again to stop the recording and save this file in AVI format.

**Note:**

1. You can preview the AVI files in Playback mode or once downloaded to your computer by using Quick Time and Windows Media Player.
2. When the camera's memory is full, the "Memory Full Insert a SD Memory Card to Transfer and Shoot More video!" message will appear on the LCD screen when you attempt shoot more videos. Download the test file from the internal memory to the PC or delete them to shoot more videos. Alternatively, you can insert a SD memory card to expand the memory to record longer videos.
3. The LCD will not light up when the light condition is not good.

In Video mode there are 3 setup options - *White Balance, Size and Macro*

**White Balance**

You can select 5 different White Balance light conditions for shooting videos.

1. Press the MENU button.



2. Press the Right/Left button to select the **WB** option.
3. Press the Up/Down buttons to select a White Balance option from the Menu that appears:

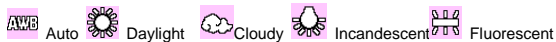

4. Press the MENU button to confirm, save and exit to the video standby mode.
5. The LCD screen will be adjusted as per the White Balance option you selected.

## Size

Your camera supports 2 video resolutions- 640x480 (VGA) pixels, 320x240 (QVGA) pixels.

1. Press the MENU button.
2. Press the Right/Left button to select the  option for the Size menu to appear.

3. Press the Up/Down buttons to select an Image Size option from the Menu that appears:  
VGA 640x480  
QVGA 320x240
4. Press the MENU button to confirm, save and exit to the video standby mode.
5. The Image Size icon selected will appear at the top of the LCD screen.

## Playback Mode

Press the HOME button to enter the Playback mode.

When the  icon appears on the top left corner of the LCD screen this indicates that you are in Playback mode.

Here you can preview the photos and videos you have captured and recorded. In Playback mode you can rotate, protect, delete and crop your photos and you can protect and delete video clips. You can also print photos directly from your camera using PictBridge.

**Note:** The message “No File Exist” will appear on the LCD screen if there are no photos or videos in your camera. Press the MODE button to return to the camera or video mode and begin to take photos or videos.

### ***Full screen to Thumbnail display***

When the camera is in the Playback Mode and an image appears on the LCD screen:

1. Press the W button.
2. This will open up the thumbnail display.
3. Press the Up/Down/Left/Right buttons and select a thumbnail of a photo or video.
4. Press the MENU button to display the photo or video in full screen.

### ***Zoom In or Out of the Photo***

1. Select a JPEG photo.
2. The icon  will display on the top left corner of the LCD screen.
3. Press the T button to 8x zoom in to the photo.
4. Press the Up/Down/Left/Right button to navigate around the photo.
5. Press the W button to zoom back out it.

### ***Operation functions for still photos***

Select the still photo you want by either selecting it in the thumbnail view first before viewing to full screen or view the images one by one in your camera by pressing the Right/Left buttons to toggle through the images that appear on the LCD.

Select the photo you wish to *rotate, protect, delete, crop or print*.

## **Rotate**

The rotate feature will only work for images on the SD card that is inserted.

1. Press the MENU button.
2. Press the Right/Left button to select the  rotate option.
3. Press the Up/Down buttons to select the Rotate option from the Menu that appears.

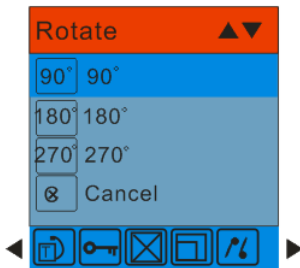

4. Press the MENU button to confirm how many degrees you want to rotate the photo
5. A "Rotate & Saving" message will appear on the screen. Please wait while the photo is rotated as per

your choice.

6. The photo will now be rotated and saved.

**Note:**

1. You cannot rotate a protected file. On attempting to rotate a protected file a “This File is Write-Protected” message will appear on the screen.
2. “No card inserted” will appear on the screen if no SD card is insert. Please insert an SD memory card to use this function.

***Protect***

You can protect your photos/videos from accidental deletion by selecting the “lock” feature.

1. Press the MENU button.
2. Press the Right/Left button to select the  protect option.
3. Press the Up/Down button to select the Protect options that appear in the menu.

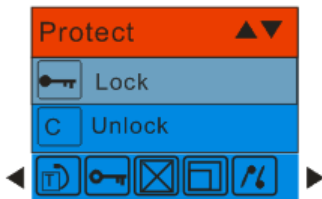

4. Press the MENU button.
5. If you select Lock, a lock icon  will appear at the top of the LCD for the photo or video selected.

**Note:** To “Unlock” the current file follow steps 1 through 4. Select “Unlock” and press the MENU button to unlock the current file.

### **Delete**

Delete unwanted photos and videos at any time in order to free up memory. You can delete one image or video clip at a time or delete all except the protected photos and videos that are currently stored and saved on the memory card.

1. Press the MENU button.
2. Press the Right/Left button to select the  Delete option.

3. Press the Up/Down button to select “This Image” (if the image is a photo) or “This Video” (if the image is a video) to delete the current photo or video you selected. Select the “All” option to delete all unprotected images. Press Cancel to exit the Delete option if you do not wish to delete anything at this stage.

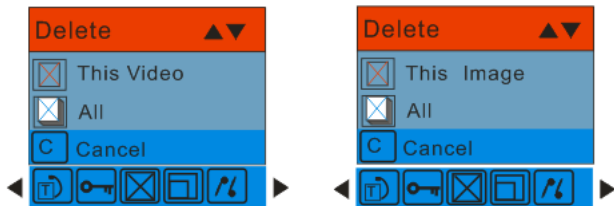

4. Press the MENU button to confirm.
5. A Delete confirmation message appears.
6. Press the Right/Left button to select “Yes” or “No”.
7. Press MENU button to confirm and delete the image(s).

**Note:** You cannot delete files that are locked.

**Caution:** If you choose the All option, all the unprotected photo images on your SD card will be deleted.

This process is irreversible and all your images will be lost forever unless you have saved them or downloaded them to your computer previous to the deletion.

## Crop Image

Crop your photos to show and save a specific portion of an image or to highlight certain focal points. The Crop feature lets you zoom in on an image and then save that part of the image as a new photo.

**Note:** Only photos on the SD Card can be cropped.

1. Press the MENU button.
2. Press the Right/Left button to select the  Crop option.
3. Press the Up/Down button to select Crop or Cancel.

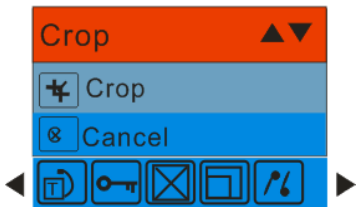

4. Press the MENU button.
5. A blue crop rectangle appears on the photo in the LCD screen.
6. Press the W or T buttons to determine the size of the area to crop.
7. Press the Up/Down/Right/Left buttons to navigate the area of the photo you wish to crop.



8. Press the Shutter button for the crop confirmation icons to appear or press the MENU button to exit.
9. Press the Shutter button to confirm and save the crop or press the MENU button to exit.
10. A Saving screen appears before the cropped photo is saved as a new photo to your camera's memory card.

### ***Print with Pictbridge***

You can print the photos directly from the camera with a Pictbridge compatible printer.

1. Select the photo you wish to print.
2. Press the MENU button.
3. Press the Right/Left button to select the  Pictbridge menu.
4. Press the Up/Down button and select Pictbridge to print photos or press Cancel to exit the menu.

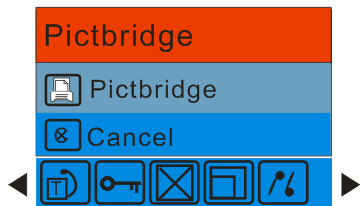

5. Press the MENU button to enter the Pictbridge mode.

6. A message will appear on the LCD to “Please connect to device”.
7. Connect your camera to a compatible printer with the USB cable provided to begin printing.
8. Press the MENU button to exit if you do not want to print.

### ***Playing the AVI video file***

1. In Playback mode, press the Left/Right buttons to select an AVI video file you wish to play.
2. Alternatively, press the W button to enter the thumbnail mode and select a video. Video have an  icon on the thumbnail. Press the MENU button for the selected video to appear in full screen.
3. Press the Shutter button to play the current AVI file.
4. Press the Up button to pause and press it again to continue playing.
5. Press the Shutter button to stop playing the AVI and revert back to the Playback mode.

**Note:** Just as with Photos so too Videos can be protected from accidental deletion as well as can be deleted.

### ***Protect***

You can protect your videos from accidental deletion by selecting the “lock” feature.

1. Press the MENU button.
2. Press the Right/Left button to select the  protect option.

3. Press the Up/Down button to select the Protect options that appear in the menu.

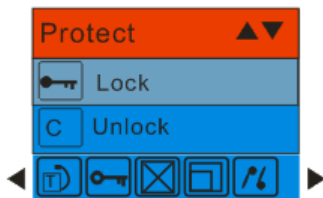

4. Press the MENU button.
5. If you select Lock, a lock icon  will appear at the top of the LCD for the video selected.

**Note:** To “Unlock” the current file follow steps 1 through 4. Select “Unlock” and press the MENU button to unlock the current file.

## **Delete**

Delete unwanted videos at any time in order to free up memory. You can delete one image or video clip at a time or delete all except the protected videos that are currently stored and saved on the memory card.

1. Press the MENU button.
2. Press the Right/Left button to select the  Delete option.

3. Press the Up/Down button to select “This Image” (if the image is a photo) or “This Video” (if the image is a video) to delete the current photo or video you selected or select the corresponding “All” option to delete all unprotected images. Press Cancel to exit the Delete option if you do not wish to delete anything at this stage.

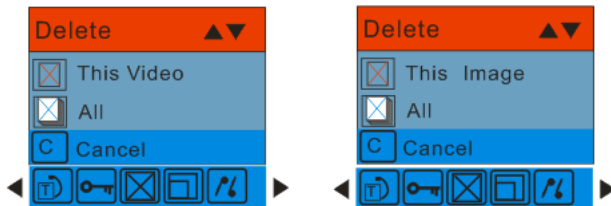

4. Press the MENU button to confirm.
5. A Delete confirmation message appears.
6. Press the Right/Left button to select “Yes” or “No”.
7. Press the MENU button to confirm and delete the image(s).

**Note:** You cannot delete files that are locked.

**Caution:** If you choose the All option, all the unprotected video images on your SD card will be deleted.

This process is irreversible and all your images will be lost forever unless you have saved them or downloaded them to your computer previous to the deletion.

## Install the Vivitar Experience Image Manager Software

**Warning:** Do not plug your camera into the computer until the software installation is complete. You must be connected to the internet to install and run the Vivitar Experience Image Manager software.

1. Insert the installation CD into your CD-ROM drive. The installation screen should automatically open.



2. On PC: The Vivitar Experience Image Manager Installer window appears. If the window does not appear, open the application's CD/DVD drive and click on "Setup.bat" to launch the installer.
3. On Macintosh: Click the icon to install the Vivitar Experience Image Manager.

- If you do not have internet access at the time of inserting the CD-ROM, connect to the internet and then click the “Install Vivitar Experience Image Manager” button to begin the installation

**Note:** If you do not have internet access, you can still download media from the camera. Click the “How to transfer photos and videos from my camera to my computer” button for instructions.



- If you have internet access, the “Choose your language” window opens, choose your language and click “Next” to open the next window.
- Select your camera model from the list and click “Next” to open the next window.
- Click “Next” to confirm your camera model selection and to install the application.
- Please wait while the application is being installed on your computer.
- Please review the license terms.

On PC: Click the “I Agree” button to continue.

On Macintosh: Click the “I accept the terms of this license agreement” and then click “Next” to continue.

10. On PC only: Let the “Vivitar Experience Image Manager” installer create the folder to where the program will be installed, and then click “Install”.
11. Please wait while the application continues the installation process on your computer.
12. On PC: Click the “Close” button when the installation is complete.  
On Macintosh: Click the “Quit” button when the installation is complete.
13. Click the “Launch Vivitar Experience Image Manager” to open the application or close the window and run the Vivitar Experience Image Manager from your computer.



## Connect your camera to the computer

1. Use the USB cable that came with your camera to connect your camera to your computer.
2. Turn the camera on.
3. The first time you connect the device to the computer you will have to wait a few seconds until the computer recognizes the device.

## Get photos and videos from your camera to your computer

An SD card needs to be inserted. Do not disconnect the cable during transfer. Doing so will cancel the transfer of any files on their way to your computer.

1. Select the “Get images” button from the Main menu.



2. The “Get media from device” window opens.
3. You can select to download photos, videos or both.



4. Select your camera (removable disk) from the device window. If your camera is the only USB device connected then it will be selected automatically.
5. Select a location on the computer where to place the new photo and video files.
6. Add the new photo and video files to albums if desired.
7. Select to remove the media files from the selected device (removable disk) after the import.
8. Click the “Get media” button to transfer the photos and videos from your camera to your computer. A media download progress bar appears on the bottom left showing the number of media files downloading to your computer. A message appears when the download is complete.
9. The photo and video files that you selected are now downloaded to your computer to the selected folder and albums ready for your use.

## **Get started!**

Using the Vivitar Experience Image Manager, you can upload and manage photos and videos to and from the most popular photo sharing and social networking sites - Facebook, Flickr, MySpace, Picasa, Photobucket and YouTube. Seamlessly transfer photos and videos from one social network to another. Organize your images by creating offline and online albums. Edit images using automatic and manual tools. Use automatic “Geotagging” with built in Google Maps.

**For more details on how to use the Vivitar Experience Image Manager open the Help file or click the “Take the Tour” button on the application`s Home page.**

## **Transfer media from my camera to my computer manually (Using Windows)**

1. Use the USB cable that came with your camera to connect your camera to your computer.
2. A window appears with a list of options, select Open folder to view files and click OK.
3. Open the DCIM folder and the folder inside to view the media files.
4. Select the media and copy the files from this folder into your computer. Optionally, select the files and choose Copy from the Edit menu. Then select a folder and choose Paste from the Edit menu.
5. We recommend that you copy the images into the Pictures/My Pictures folder and the videos into the Videos/My Videos folder.
6. Do not disconnect the cable during transfer. Doing so will cancel the transfer of any files on their way to your computer.

## **Transfer media from my camera to my computer manually (Using Macintosh)**

1. Use the USB cable that came with your camera to connect your camera to your computer.
2. The camera's device icon appears on the desktop.
3. Click on the device icon and open the DCIM folder and the folder inside to view the media files.
4. Select the files and drag them into your computer. Optionally, select the files and choose Copy from the Finder's Edit menu. Then select a folder and choose Paste from the Edit menu.
5. We recommend that you copy the images into the Pictures folder and the videos into the Movies folder.
6. Do not disconnect the cable during transfer. Doing so will cancel the transfer of any files on their way to your computer.

## Maintenance of Your Digital Camera

The digital camera is a delicate device. Please handle your camera with care to avoid damaging it.

## Sakar Warranty Card

This warranty covers for the original consumer purchaser only and is not transferable. Products that fail to function properly **UNDER NORMAL USAGE**, due to defects in material or workmanship. Your product will be repaired at no charge for parts or labor for a period of one year.

What Is Not Covered By Warranty:

Damages or malfunctions not resulting from defects in material or workmanship and damages or malfunctions from other than normal use, including but limited to, repair by unauthorized parties, tampering, modification or accident.

What To Do When Service Is Required:

When returning your defective product (postage pre-paid) for service, your package should include:

1. Copy of **original** bill of sale
2. A detailed written description of the problem.
3. Your return address and telephone number (Daytime)

MAIL TO ADDRESS BELOW:

<u>Sakar US</u> Sakar International Attention: Service Department 195 Carter Drive Edison, NJ 08817	<u>Sakar UK/Europe</u> Attention: Service Department 2D, Siskin Parkway East 4020 Middlemarch Business Park Coventry, CV3 4PE	<u>Sakar Australia</u> Return faulty camera to the Refund Counter at the store where purchased
--	---	---

## Technical Support

For technical support issues please visit our website at **[www.vivitar.com](http://www.vivitar.com)**. You can find manuals, software and FAQ's at the website. Can't find what you are looking for? E-mail us at **[support@vivitar.com](mailto:support@vivitar.com)** and one of our technical support team members will answer your questions. For phone support in the US please call 1-800-592-9541, in the UK call 0800 917 4831, in Australia call 1800-006-614. If you would like to call from anywhere else, please visit **[www.vivitar.com](http://www.vivitar.com)** for your local toll free number.

## Technical Specifications

Image Sensor	CMOS Sensor
Image Resolution	4000x3000 (12MP), 3648x2736(10MP),3264x2448(8MP), 3648x2048(7MP) HD, 2592x1944(5MP), 2048x1536(3MP), 1920x1080(2MP) HD, 640x480(VGA)
Video Resolution	640X480,320X240pixels
File Format	JPEG/AVI
External Memory	SD Card (up to 8GB)
LCD Display	2.4 Inch TFT
Lens	f=7.45mm F3.0 with Mechanical Shutter
Zoom	8X Digital Zoom
Exposure	-3.0EV ~ +3.0EV
White Balance	Auto, Daylight, Cloudy, Incandescent , Fluorescent
ISO	Auto/100/200/400
Scene	Auto/Night Portrait/Night Scenery/Portrait/Scenery/Sport/Party/Beach/High Sensitivity
Flash	Auto /Force/Red Eye Reduction/Off
Self-timer	2, 5 or 10 sec delay
Anti-Shake	Yes
PictBridge	Yes
Face Detect	Yes
Interface	USB 2.0
System Requirements	Windows XP (SP2)/ Vista/ Mac OS X (10.5 or higher)
Battery	3 * AAA batteries
Working Temperature	0~40 °C

## Troubleshooting

**Q: I have taken photos and selected the “Get Images” button. I get a message that the images were successfully transferred but the photos do not appear on my computer. What do I do?**

First ensure that you have in fact taken photos. Press the Shutter button to take some sample photos and then try downloading them again.

With test photos if the camera powers off before you upload them to the computer the photos are not stored in the camera's memory. These photos should be uploaded quickly before the camera powers off.

If the photos are saved to the SD memory card then all the photos should appear.

**Q: How do I make sure I don't lose important pictures?**

Your camera uses SDRAM memory, which requires a constant electric current to store your test photos.

Should your camera lose power (for instance if the battery dies or run out of power) the photo will be lost. This camera requires an SD card for normal use. If the camera powers off nothing will happen to the images stored on the SD memory card. We recommend always downloading your photos to your computer as soon as possible to prevent unintentional data loss.

**Q: I deleted images using the Vivitar Experience Image Manager. The image was also deleted from my computer. How do I recover images that I accidentally deleted?**

All images deleted using the Vivitar Experience Image Manager are sent to your computer's Recycle or Trash Bin and can be retrieved from there.

VT024-050910\_1-TA